



GRC Secchia Piazza

REVITALIZING CAMPUS SPACES: THE STORY OF SECCHIA PIAZZA



Ned Baxter

SENIOR DESIGN ARCHITECT
PROGRESSIVE COMPANIES

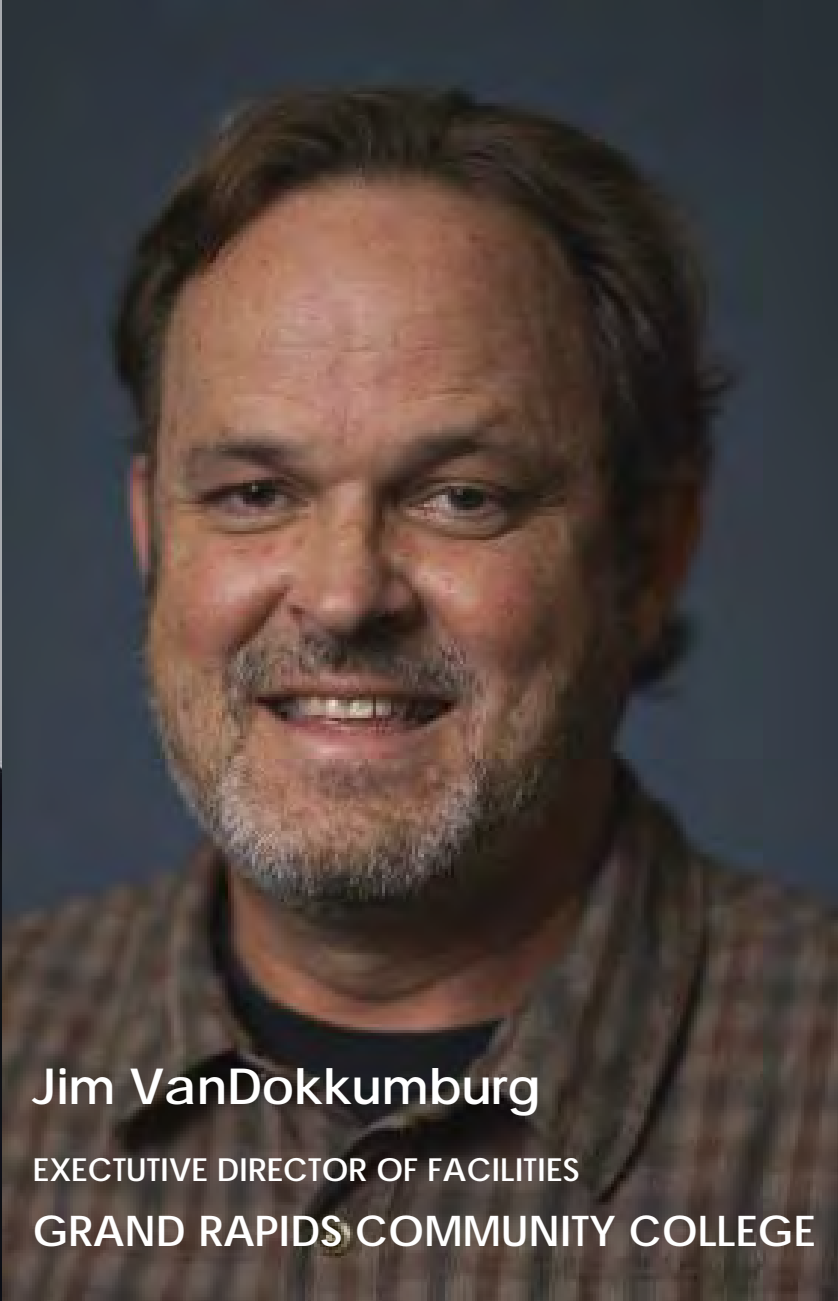

Jim VanDokkumburg

EXECUTIVE DIRECTOR OF FACILITIES
GRAND RAPIDS COMMUNITY COLLEGE



Brad Hesche

REGIONAL VICE PRESIDENT, WEST MICHIGAN
GRANGER CONSTRUCTION

Introducing the team

GRCC Today



Peter Secchia



The Secchia Institute for Culinary Education



Pietro and Regina Amphitheater



"Peter's Pub" @ Fountain Hill Brewery



GRCC Wisner-Bottrall Applied Technology Center

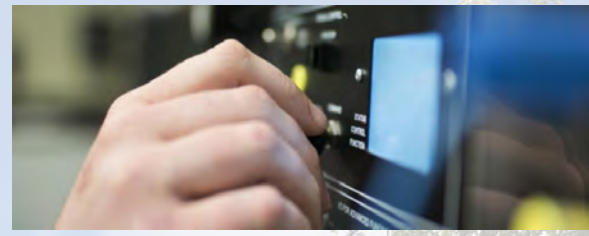

Electronics Engineering Technology



The Secchia Institute for Culinary Education



Architecture and HVAC Engineering Design



Manufacturing and Computer Information Systems



Ferris State University Offices



Classrooms & Study Spaces



HVAC / Refrigeration Technology



Plastics-Polymers Engineering Technology

GRCC Wisner-Bottrall Applied Technology Center



BEFORE CONSTRUCTION

GRCC Wisner-Bottrall Applied Technology Center



BEFORE CONSTRUCTION

Concept Design

Piazza

The piazza strengthens local identity while reaffirming the cultural past of a people rooted in centuries of history.

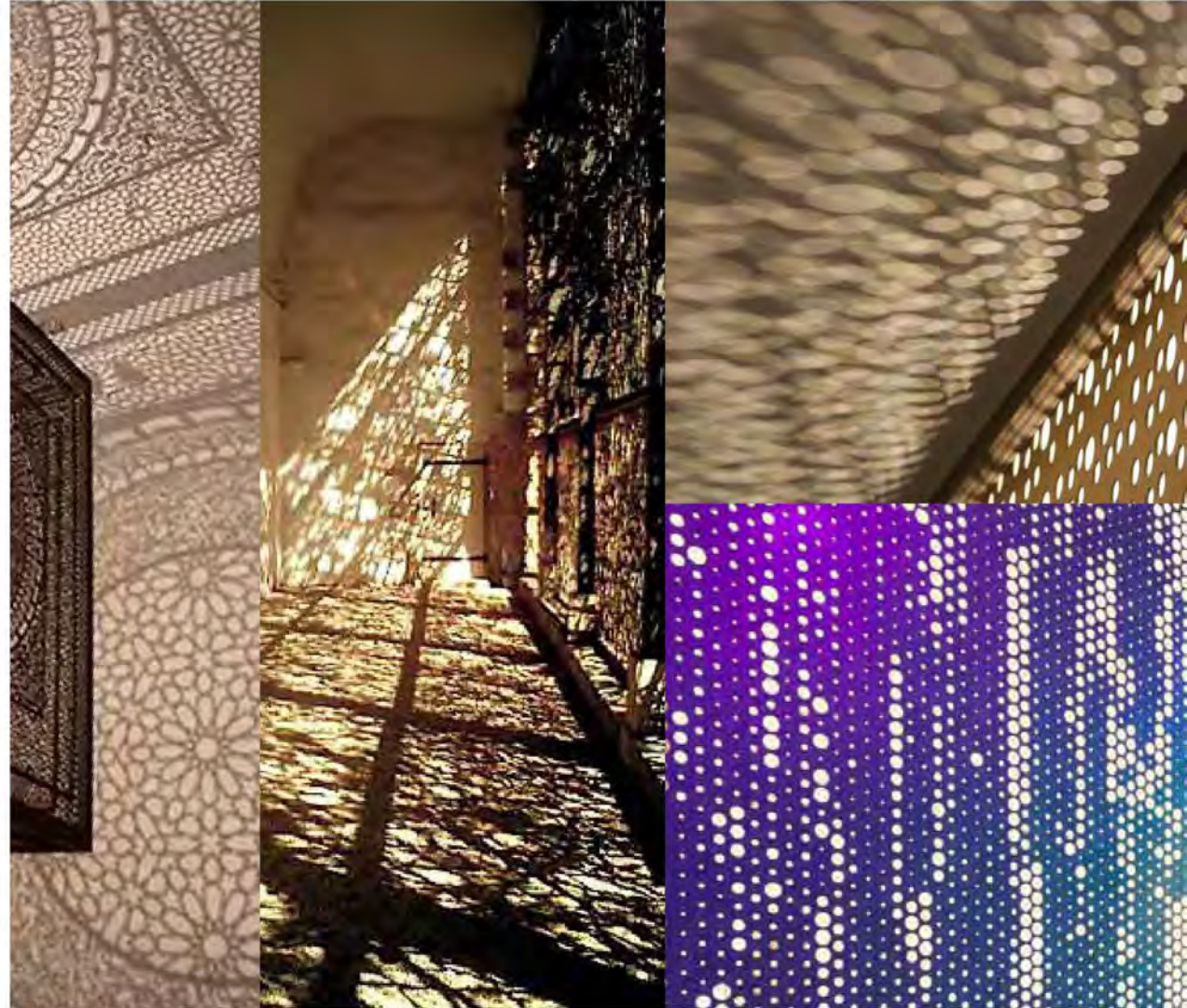

Concept Design

Piazza

The piazza was the fabric of life which wove together all walks of life.



Concept Design

Piazza

Voices and music boom throughout the outdoor living room creating a jovial atmosphere. There is a truly interesting interplay between those who watch and those who partake in the piazza scene and in this sense, the piazza could be considered a neverending play.



Concept Design

Piazza

The piazza also reminds citizens where they have come from, walking amongst history every day. And for this reason, perhaps, Italians enjoy their roots in a way Americans yet cannot

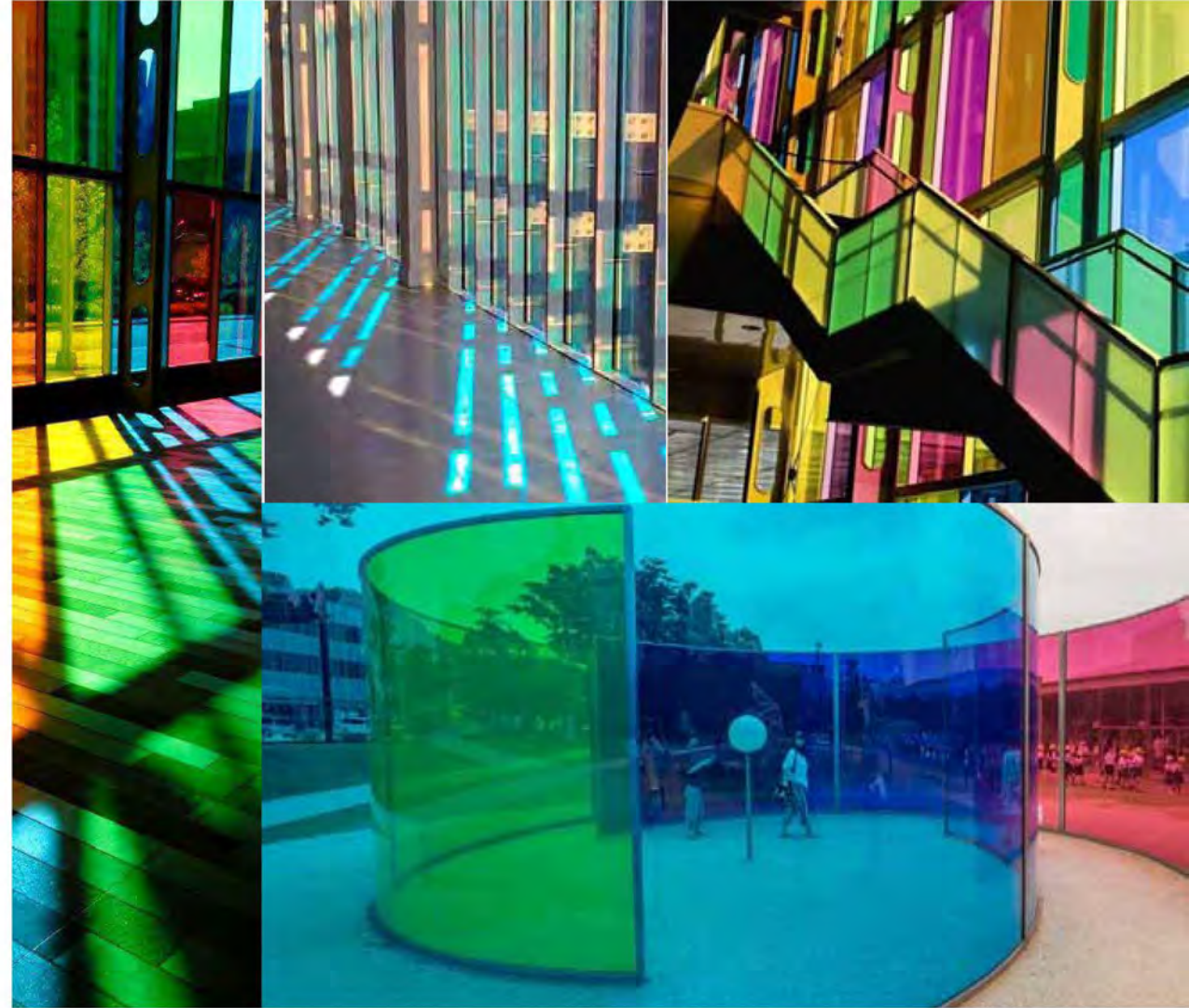

Concept Design



Concept Design



Transformation



Site Context

A BEACON CONNECTING THE COLLEGE AND ITS CITY



Connected to Heartside Arts and Cultural District

Project Plan

INTERCONNECTED SPACES FOR GATHERING AND EDUCATION

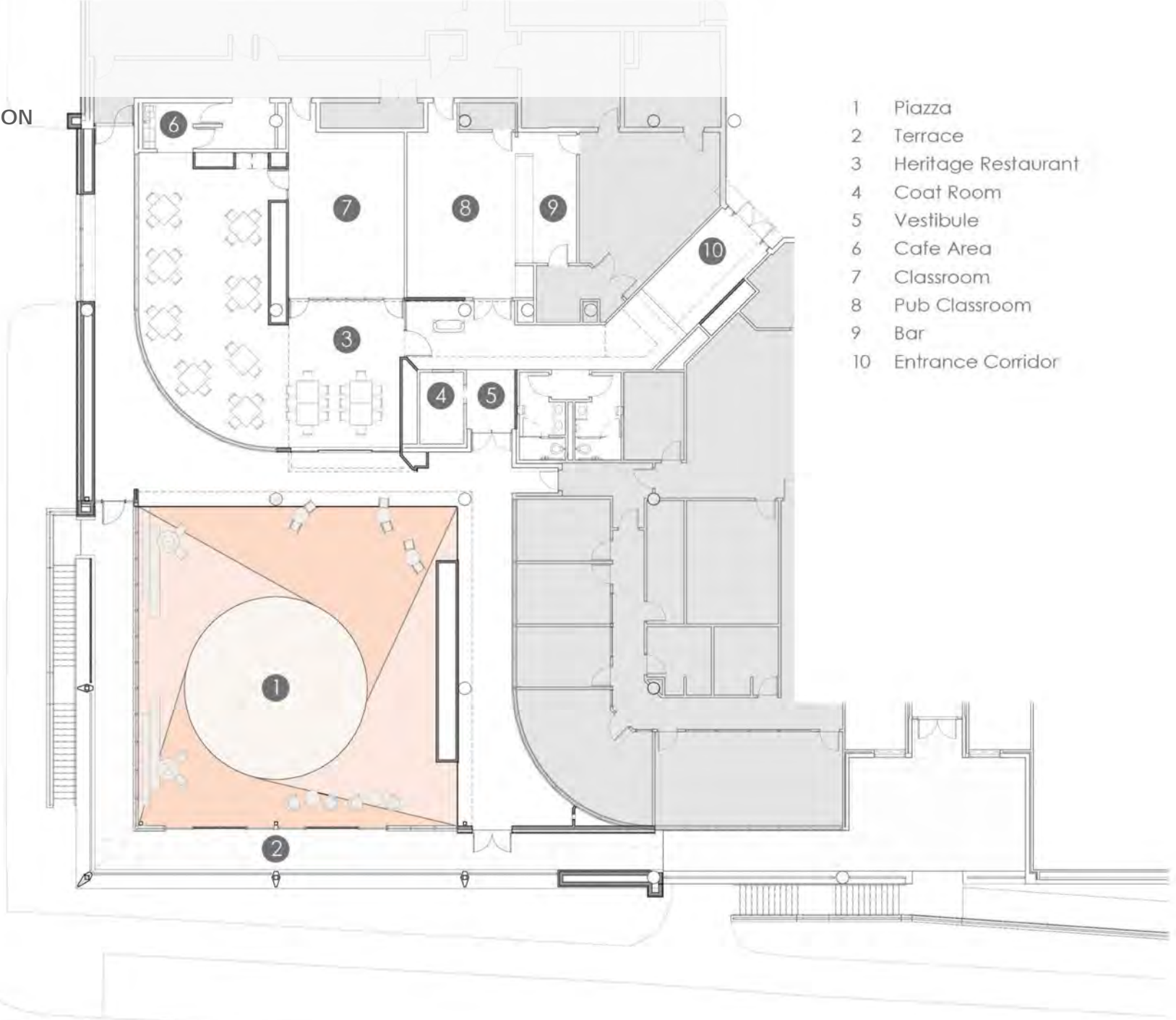

Project Section

INTERCONNECTED SPACES FOR GATHERING AND EDUCATION

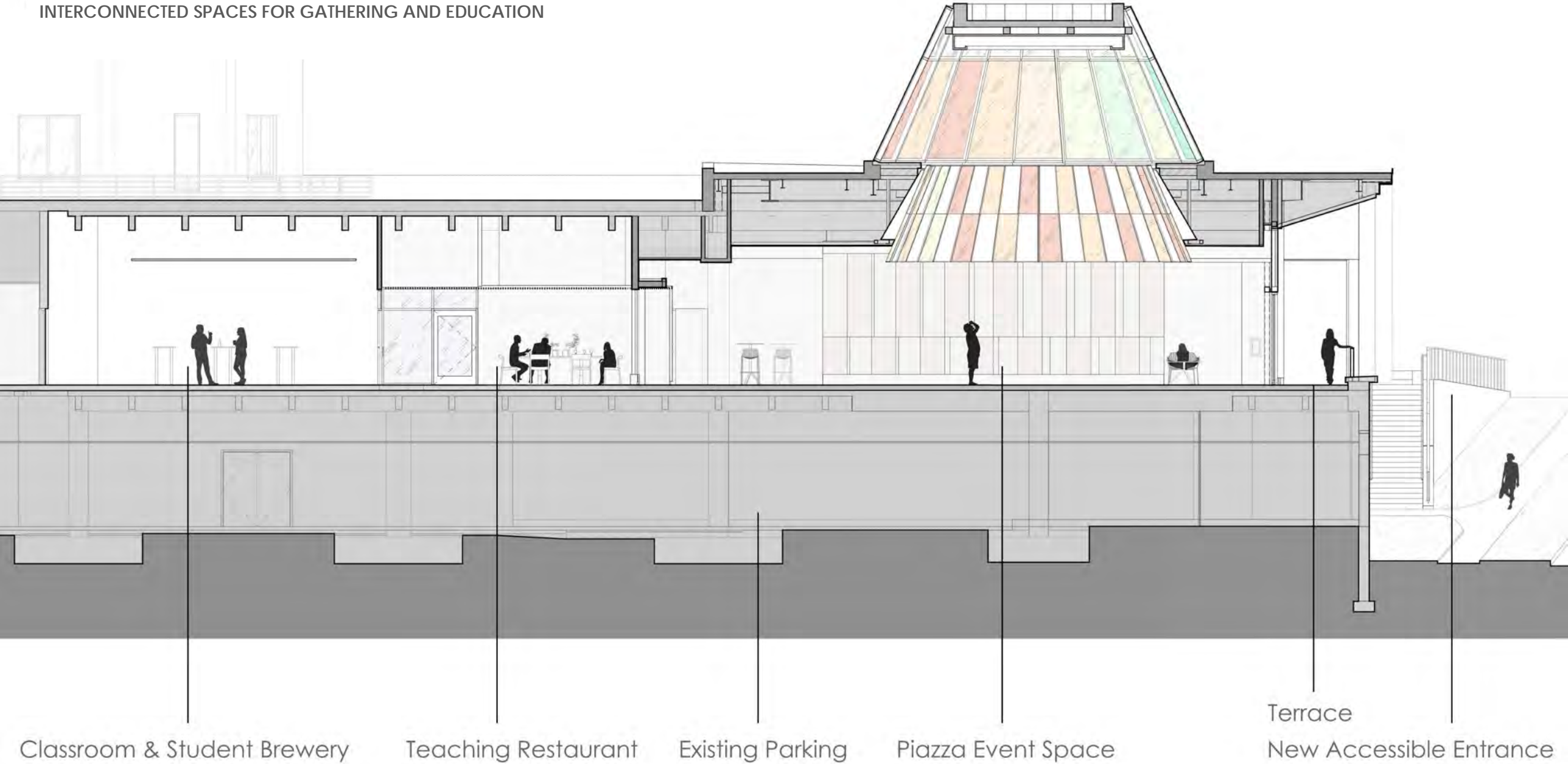

Classroom & Student Brewery

Teaching Restaurant

Existing Parking

Piazza Event Space

Terrace
New Accessible Entrance

Project Construction





Secchia Institute for Culinary Education

AHEAD
No Parking

GRCC
Wisner-Bottrall
Applied
Technology
Center
151 FOUNTAIN ST NE

Ferris State University
Fountain Hill Brewery
Heritage Restaurant

KENT COUNTY'S
No. 1
COLLEGE
CHOICE
GRCC.EDU

Ransom
Fountain

COMPLETED: View from renovated restaurant to Piazza beyond.



BEFORE: View of restaurant and adjacent roof terrace.





Project Details

Sophisticated Design Integration

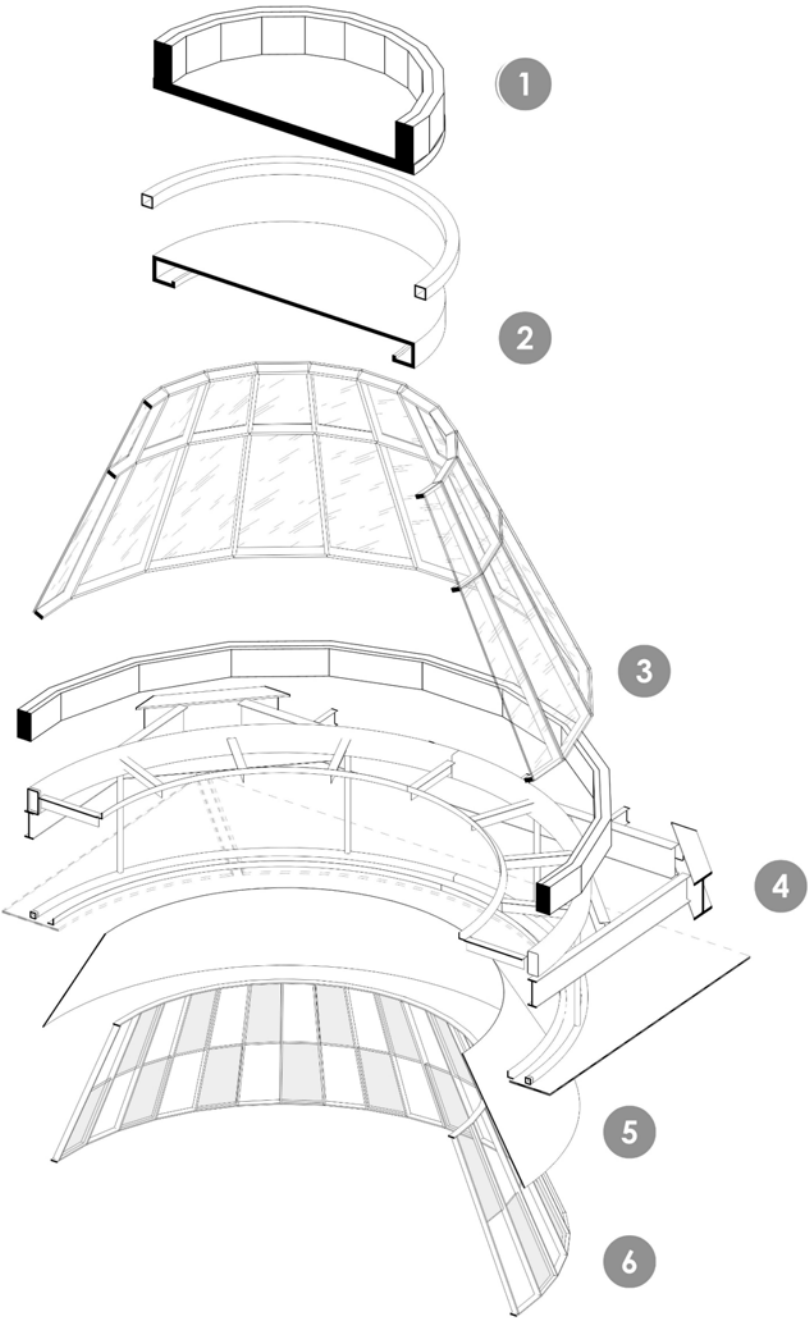

- 1. Steel skylight structure, insulation, and membrane
- 2. Stretched acoustical fabric lighting cove
- 3. Colored glass roof monitor
- 4. Steel roof structure
- 5. Stretched ceiling membrane
- 6. Acrylic acoustical panels on aluminum structure

Project Inspiration



Home...

Landscape...

Harvest...

Hospitality...

Color...

Community...



Inspirations for project design

Project Construction









A Sustainable Part of Campus



Accessible For All



A Joyful Reception



A joyful reception of the project by the College.

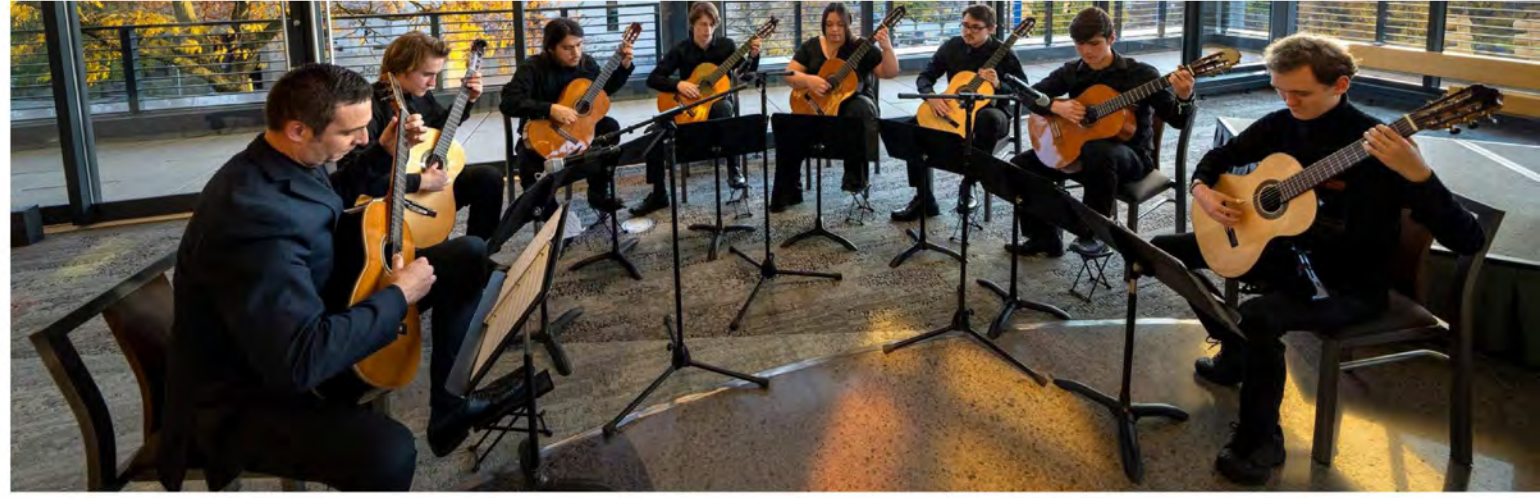

A Catalyst for Transformation



LEARNING RESOURCE CENTER





An Iconic Addition to the City



Thank You.